

JEILMEDICAL

# Dual Top<sup>®</sup> ANCHOR SYSTEM

Self Drilling & Self Tapping



# Contents

3	Indications
4	Features and Benefits
5	Procedures
	Ordering Information
11	- Dual Top Anchor System Screws
16	- Dual Top Anchor System Accessories
17	- Dual Top Anchor System Driver Shafts
18	- Anchor Plate System
21	- Orthonia



### **Dual Top**<sup>®</sup> ANCHOR SYSTEM

Self Drilling & Self Tapping

**Dual Top Anchor System** is used to provide a fixed anchorage point for attachment of orthodontic appliances to facilitate the orthodontic movement of teeth. It is used temporarily and is removed after orthodontic treatment has been completed.

Screws are intended for single use only.

For use on adults over the age of 12.

## Features and Benefits

### Titanium Alloy Material

- Increased compatibility with CT and MRI
- Biocompatible, corrosion-resistant and non-toxic in a biological environment.

### Thread Length Choice

For best fit of distal threads into far bone fragment to bear increased interfragmentary compression.

### Self-Tapping Flutes

Reduced OR time by eliminating the need for tapping.

### Immediate Loading

Dual Top works as an anchor for immediate loading

### Collar for Gingiva Protection

Each screw has collar

### No Incision and Flapping

Self-drilling and self-tapping allows no incision

### Easy Removal

After the treatment, remove the screw by simple unscrewing

### Applicable to Various Locations

It is small and can be implanted in different areas where needed.

**Dual Top**<sup>®</sup> ANCHOR SYSTEM



## Preparation

### Determining the implant location

Use any metal device and x-ray image to determine the space between the roots of the teeth.

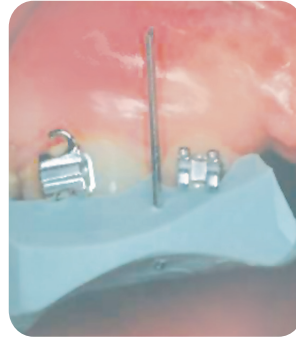

Metal Device



X-Ray Photo

### Local anaesthesia

Local anaesthesia is required to insert Dual Top screws.

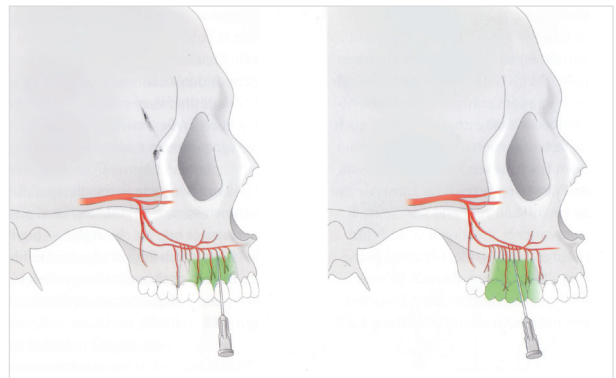

## Screw pick-up

Use driver shaft and handle to pick-up



Use either manual shaft body or electric hand piece (sold separately)

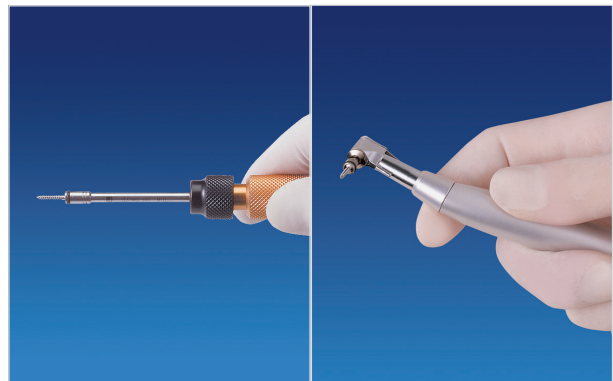

Make sure screw is attached at correct angle for insertion

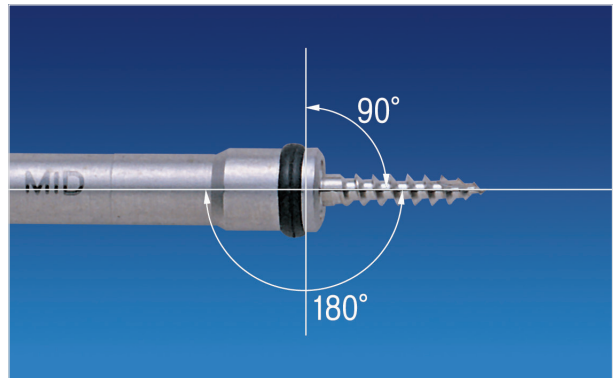

### Required Instruments



Driver Shaft



Screwdriver Handle  
111-010



Orthonia  
111-ED-040



Orthonia  
111-ED-010

## Screw Insertion

Dual Top can be inserted without incision, flapping and drilling. Pre-drilling maybe required depending on bone density.

Push gently on driver body and rotate the gold part of the body clockwise.

Check the screw fixation by gently touching and pulling the screw.



### Required Instruments



Driver Shaft



Screwdriver Handle  
111-010

## Optional

An electric handpiece can be used for the screw insertion.  
The RPM must be lower than 30.



### Required Instruments



Orthonia  
111-ED-040



Orthonia  
111-ED-010



**Palatal**

Suitable for Mid-palatal suture area insertion.

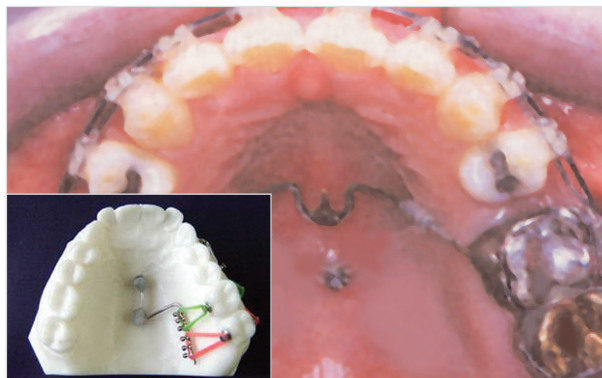
**Maxilla**

Suitable for attached gingiva insertion.

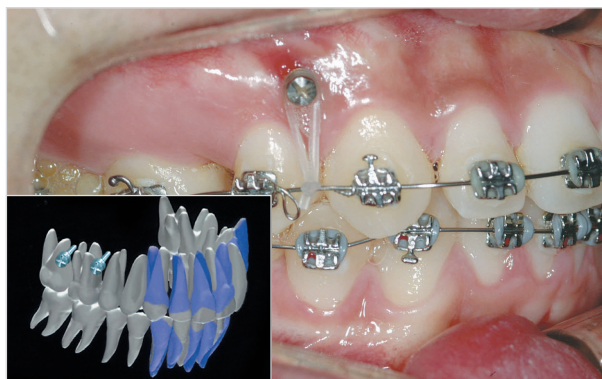
**Mandible**

Suitable for retromolar area, buccal shelf, or buccal alveolus insertion.





## Dual Top Anchor System Screws

## JA Screws

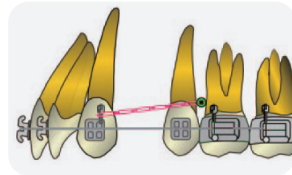
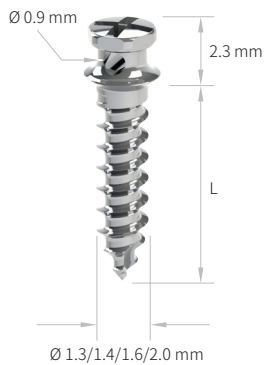

For elastic band



## JA Screws with hole

Code	Outer Diameter	Length(L)
13-JA-005H	Ø 1.3 mm	5 mm
13-JA-006H	Ø 1.3 mm	6 mm
13-JA-008H	Ø 1.3 mm	8 mm
14-JA-006H	Ø 1.4 mm	6 mm
14-JA-008H	Ø 1.4 mm	8 mm
14-JA-010H	Ø 1.4 mm	10 mm
16-JA-005H	Ø 1.6 mm	5 mm
16-JA-006H	Ø 1.6 mm	6 mm
16-JA-008H	Ø 1.6 mm	8 mm
16-JA-010H	Ø 1.6 mm	10 mm
16-JA-012H	Ø 1.6 mm	12 mm
20-JA-005H	Ø 2.0 mm	5 mm
20-JA-006H	Ø 2.0 mm	6 mm
20-JA-008H	Ø 2.0 mm	8 mm
20-JA-010H	Ø 2.0 mm	10 mm
20-JA-012H	Ø 2.0 mm	12 mm

\* SXX-JA-XXXH: Sterilized JA Screws with hole

## JA Screws without hole

Code	Outer Diameter	Length(L)
14-JA-006N	Ø 1.4 mm	6 mm
14-JA-008N	Ø 1.4 mm	8 mm
14-JA-010N	Ø 1.4 mm	10 mm
16-JA-006N	Ø 1.6 mm	6 mm
16-JA-008N	Ø 1.6 mm	8 mm
16-JA-010N	Ø 1.6 mm	10 mm
20-JA-006N	Ø 2.0 mm	6 mm
20-JA-008N	Ø 2.0 mm	8 mm
20-JA-010N	Ø 2.0 mm	10 mm

\* SXX-JA-XXXN: Sterilized JA Screws without hole

## JF Screws



Smooth head

## JF Screws

Code	Outer Diameter	Length(L)
14-JF-006	Ø 1.4 mm	6 mm
14-JF-008	Ø 1.4 mm	8 mm
16-JF-006	Ø 1.6 mm	6 mm
16-JF-008	Ø 1.6 mm	8 mm
16-JF-010	Ø 1.6 mm	10 mm

\* SXX-JF-XXX: Sterilized JF Screws

## JB Screws

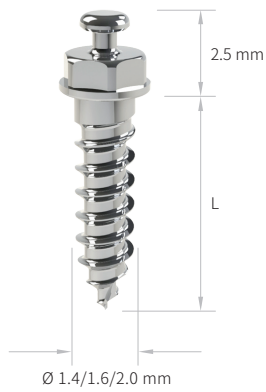

For elastic band

### JB Screws with hole

Code	Outer Diameter	Length(L)
16-JB-006H	Ø 1.6 mm	6 mm
16-JB-008H	Ø 1.6 mm	8 mm
16-JB-010H	Ø 1.6 mm	10 mm
20-JB-008H	Ø 2.0 mm	8 mm
20-JB-010H	Ø 2.0 mm	10 mm
20-JB-012H	Ø 2.0 mm	12 mm

\* SXX-JB-XXXH: Sterilized JB Screws with hole

### JB Screws without hole

Code	Outer Diameter	Length(L)
14-JB-006	Ø 1.4 mm	6 mm
14-JB-008	Ø 1.4 mm	8 mm
14-JB-010	Ø 1.4 mm	10 mm
16-JB-006	Ø 1.6 mm	6 mm
16-JB-008	Ø 1.6 mm	8 mm
16-JB-010	Ø 1.6 mm	10 mm
16-JB-012	Ø 1.6 mm	12 mm
20-JB-006	Ø 2.0 mm	6 mm
20-JB-008	Ø 2.0 mm	8 mm
20-JB-010	Ø 2.0 mm	10 mm
20-JB-012	Ø 2.0 mm	12 mm

\* SXX-JB-XXX: Sterilized JB Screws without hole

## G1 Screws

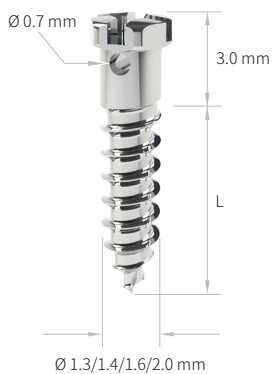

For arch wire 0.022x0.028 Inch



### G1 Screws

Code	Outer Diameter	Length(L)
13-G1-006	Ø 1.3 mm	6 mm
13-G1-008	Ø 1.3 mm	8 mm
14-G1-006	Ø 1.4 mm	6 mm
14-G1-008	Ø 1.4 mm	8 mm
16-G1-006	Ø 1.6 mm	6 mm
16-G1-008	Ø 1.6 mm	8 mm
16-G1-010	Ø 1.6 mm	10 mm
20-G1-006	Ø 2.0 mm	6 mm
20-G1-008	Ø 2.0 mm	8 mm
20-G1-010	Ø 2.0 mm	10 mm

\* SXX-G1-XXX: Sterilized G1 Screws

G2 Screws

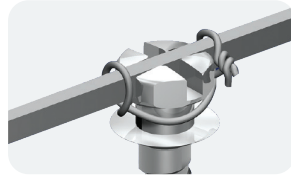
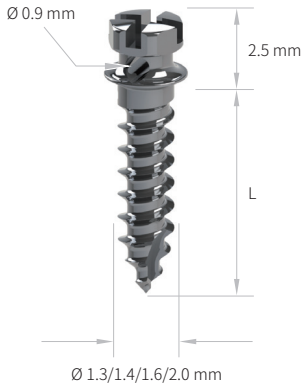

For arch wire 0.022x0.028 Inch



G2 Screws with hole

Code	Outer Diameter	Length(L)
13-G2-006	Ø 1.3 mm	6 mm
13-G2-008	Ø 1.3 mm	8 mm
14-G2-006	Ø 1.4 mm	6 mm
14-G2-008	Ø 1.4 mm	8 mm
14-G2-010	Ø 1.4 mm	10 mm
16-G2-006	Ø 1.6 mm	6 mm
16-G2-008	Ø 1.6 mm	8 mm
16-G2-010	Ø 1.6 mm	10 mm
16-G2-012	Ø 1.6 mm	12 mm
20-G2-005	Ø 2.0 mm	5 mm
20-G2-006	Ø 2.0 mm	6 mm
20-G2-008	Ø 2.0 mm	8 mm
20-G2-010	Ø 2.0 mm	10 mm
20-G2-012	Ø 2.0 mm	12 mm

\* SXX-G2-XXX: Sterilized G2 Screws with hole

G2 Screws without hole

Code	Outer Diameter	Length(L)
14-G2-006N	Ø 1.4 mm	6 mm
14-G2-008N	Ø 1.4 mm	8 mm
14-G2-010N	Ø 1.4 mm	10 mm
16-G2-006N	Ø 1.6 mm	6 mm
16-G2-008N	Ø 1.6 mm	8 mm
16-G2-010N	Ø 1.6 mm	10 mm
20-G2-006N	Ø 2.0 mm	6 mm
20-G2-008N	Ø 2.0 mm	8 mm
20-G2-010N	Ø 2.0 mm	10 mm

\* SXX-G2-XXXN: Sterilized G2 Screws without hole

JK Screws

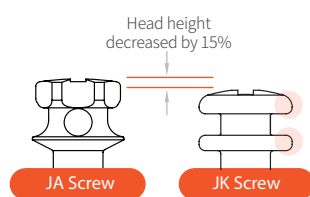
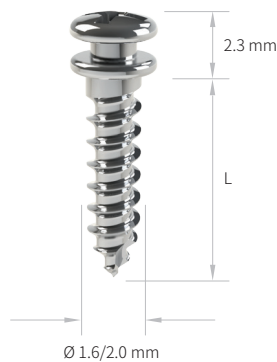

Rounded screw head to reduce the risk of soft tissue irritation

JK Screws

Code	Outer Diameter	Length(L)
16-JK-006	Ø 1.6 mm	6 mm
16-JK-008	Ø 1.6 mm	8 mm
16-JK-010	Ø 1.6 mm	10 mm
20-JK-006	Ø 2.0 mm	6 mm
20-JK-008	Ø 2.0 mm	8 mm
20-JK-010	Ø 2.0 mm	10 mm

\* SXX-JK-XXX: Sterilized JK Screws

## JD Screws

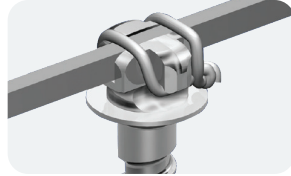
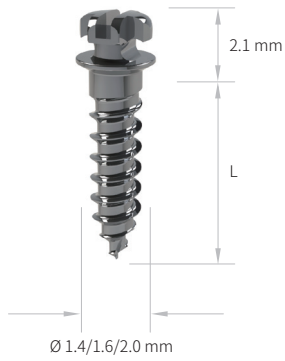

For arch wire 0.022x0.028 Inch



JD Screws		
Code	Outer Diameter	Length(L)
14-JD-006	Ø 1.4 mm	6 mm
14-JD-008	Ø 1.4 mm	8 mm
14-JD-010	Ø 1.4 mm	10 mm
16-JD-006	Ø 1.6 mm	6 mm
16-JD-008	Ø 1.6 mm	8 mm
16-JD-010	Ø 1.6 mm	10 mm
20-JD-005	Ø 2.0 mm	5 mm
20-JD-006	Ø 2.0 mm	6 mm
20-JD-008	Ø 2.0 mm	8 mm
20-JD-010	Ø 2.0 mm	10 mm

\* SXX-JD-XXX: Sterilized JD Screws

## MIM Screws Minimally Invasive Mini-Implant Screw

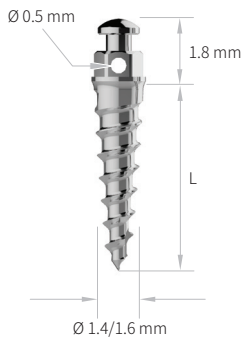

MIM Screw



JB Screw

MIM Screws		
Code	Outer Diameter	Length(L)
14-MIM-006	Ø 1.4 mm	6 mm
14-MIM-008	Ø 1.4 mm	8 mm
16-MIM-006	Ø 1.6 mm	6 mm
16-MIM-008	Ø 1.6 mm	8 mm

\* SXX-MIM-XXX: Sterilized MIM Screws

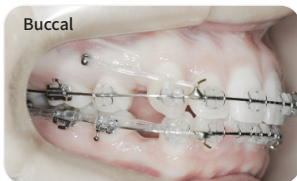

## JS Screws



For molar distalization appliance

JS Screws		
Code	Outer Diameter	Length(L)
20-JS-010	Ø 2.0 mm	10 mm
20-JS-012	Ø 2.0 mm	12 mm
20-JS-014	Ø 2.0 mm	14 mm
25-JS-012	Ø 2.5 mm	12 mm
25-JS-014	Ø 2.5 mm	14 mm
25-JS-016	Ø 2.5 mm	16 mm

\* SXX-JS-XXX: Sterilized JS Screws

## Instruments

## Dual Top Anchor System Containers



112-060



112-070



112-071

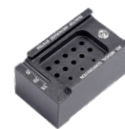

112-072



112-073

Code	Description	Set Quantity
112-060	Screw Block	1
112-070	Screw Block	1
112-071	Screw Block	1
112-072	Screw Block	1
112-073	MIM Block	1

## Dual Top Anchor System Accessories

### Impression Cap & JA / JD / G2 Screw Replica

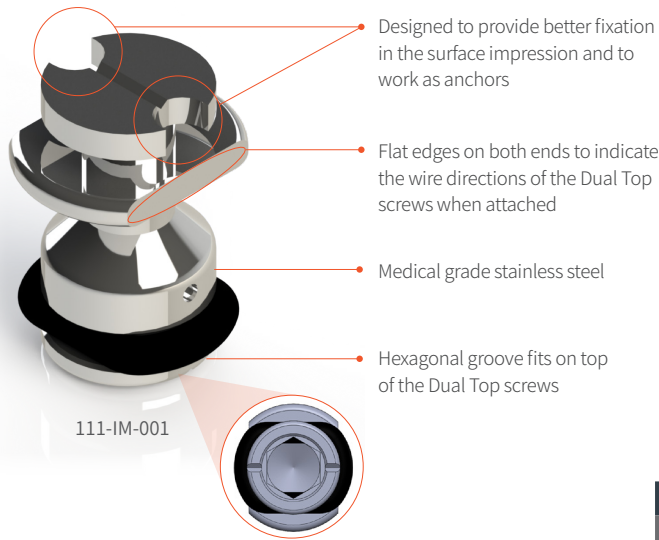

- Impression Cap(attachable on the screw head) & Replica Screws(with identical head shape)
- For More precise palatal wire fit & comfort for the patients
- Reflects exact position & angle of the actual screw inserted

Impression Cap & Replica Screws		
Code	Description	Quantity
111-IM-001	Impression Cap	1
111-RP-JA	JA Screw Replica	4pcs/pack
111-RP-JD	JD Screw Replica	4pcs/pack
111-RP-G2	G2 Screw Replica	4pcs/pack

### How to use Impression Cap



Step 1: Insertion of Dual Top screws in palatal area



Step 2: Attach the impression caps on Dual Top screws



Step 3: Perform surface impression of the patient

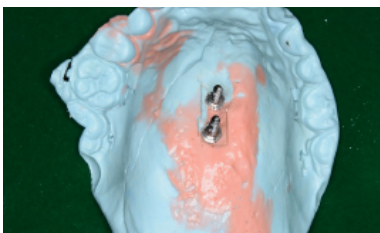

Step 4: Check the location of the impression caps and attach the replica screws















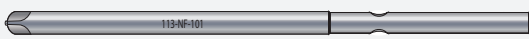

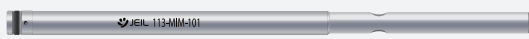

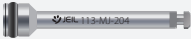

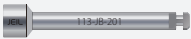
Step 5: Use impression plaster to reconstruct palatal structure with replica screws



Step 6: Use replica screws as abutments for making the palatal braces

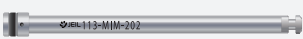

## Dual Top Anchor System Driver Shafts

Driver Shaft for Screwdriver Handle		Code	Applicable Screw									Length
			JA	JB	JD	G1	G2	JK	JF	JS	MIM	
		113-MJ-103	◆		◆			◆		◆	◆	70 mm
		113-JB-101		◆								70 mm
		113-MD-101	◆								◆	70 mm
		113-NF-101							◆			70 mm
		113-GD-101				◆	◆					70 mm
		113-MIM-101									◆	70 mm
Driver Shaft for Contra Angle		Code	Applicable Screw									Length
			JA	JB	JD	G1	G2	JK	JF	JS	MIM	
		113-MJ-203	◆		◆			◆		◆	◆	20 mm
		113-MJ-204	◆		◆			◆		◆	◆	28 mm
		113-MJ-202	◆		◆			◆		◆	◆	40 mm
		113-JB-201		◆								25 mm
		113-JB-202		◆								40 mm
		113-MD-201	◆								◆	20 mm
		113-NF-201							◆			20 mm
		113-GD-201				◆	◆					20 mm
		113-GD-211				◆	◆					40 mm
		113-MIM-202								◆	◆	40 mm
		113-MIM-201								◆	◆	20 mm
Drill	Drill Bit Diameter (A)	Code	Applicable Screw									Length
			JA	JB	JD	G1	G2	JK	JF	JS	MIM	
	Ø 1.0 mm	112-MC-201	◆	◆	◆	◆	◆	◆	◆	◆	◆	28 mm
Screwdriver Handle		Code	Applicable Screw									Length
			JA	JB	JD	G1	G2	JK	JF	JS	MIM	
		111-010	◆	◆	◆	◆	◆	◆	◆	◆	◆	110 mm

## Orthodontic Anchor Plate System

Anchor plates are made of pure titanium suitable for osseointegration and tissue integration. Anchor plates are developed to provide intraoral absolute anchorage for the intrusion or distalization of molars. Anchor plates do not disturb any kind of tooth movement because they are placed outside the dentition.

This is the most distinctive features of anchor plates in comparison with other orthodontic implant systems.

### Biomechanics for molar movement

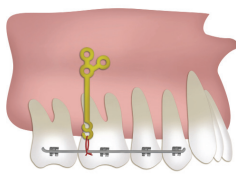

A Intrusion of upper molars

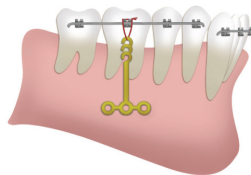

B Intrusion of lower molars

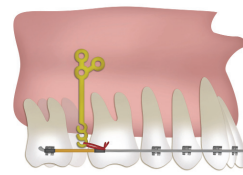

C Distalization of upper molars

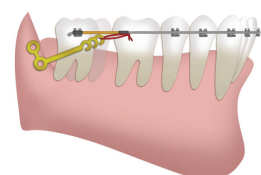

D Distalization of lower molars

### Anchor Plates

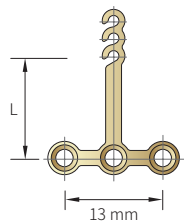

Code	Length(L)
AP-TL-010	10 mm
AP-TL-013	13 mm
AP-TL-016	16 mm

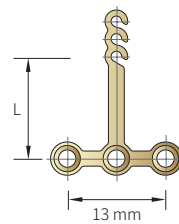

Code	Length(L)
AP-TR-010	10 mm
AP-TR-013	13 mm
AP-TR-016	16 mm

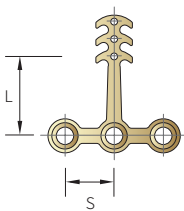

Code	Length(L)	Distance between holes(S)
AP-TS-010M	10 mm	5.75 mm
AP-TL-016M	16 mm	5.75 mm
AP-TM-013S	13 mm	5.0 mm
AP-TM-013M	13 mm	5.75 mm
AP-TM-013L	13 mm	6.5 mm

### 2.0 Auto Screws (Self-drilling)

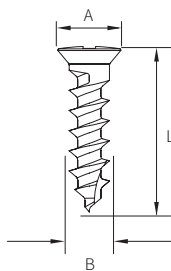

Code	Head Diameter(A)	Screw Diameter(B)	Length(L)
20-AT-004	Ø 3.0 mm	Ø 1.95 mm	4 mm
20-AT-006			6 mm
20-AT-008			8 mm
20-AT-010			10 mm
20-AT-012			12 mm

\*Cruciate-Slot, Self-Drilling, Self Tapping

## Anchor Plate System Instruments

## Screwdriver Handle



<i>Code</i>	<i>Description</i>
111-010	Screwdriver Handle

## Screwdriver Shaft



<i>Code</i>	<i>Description</i>
113-MN-101	Screwdriver Shaft

## Drill Bit



<i>Code</i>	<i>Description</i>
112-MN-201	Drill Bit for 2.0 Auto Screws (Self-drilling)



## Orthonia

A highly efficient battery-powered torque driver for the Dual Top screws. Helps to prevent screw breakage.



**Driver Holder**  
Straight type

No wobbling rotation by accurate axis  
Boosts success rate of screw fixation  
Precise torque limit control  
Prevents screw breakage



**Driver Holder**  
Angle type

All intraoral approach  
360° rotating hand piece  
Reduces OR time

111-AN-020



111-ED-040



111-ED-010

Code	Speed level (RPM)	Torque
111-ED-040	Low (30) / Mid (40) / High (50)	10N · cm, 15N · cm, 20N · cm, 25N · cm, 30N · cm
111-ED-010	Low (15) / High (20)	10N · cm, 15N · cm, 20N · cm, 25N · cm, 30N · cm

## Lingual Driver



Dentists can approach all intraoral areas by revolutionary 360° rotating hand piece

Code	Description
111-LD-020	Lingual Driver

## Finger Driver

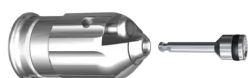

Finger Driver is designed for an easy implantation of the Dual Top® Screws at lingual or palatal area

Code	Description
111-120	Finger Driver





**JEILMEDICAL**

**JEILMEDICAL CORPORATION**

702 · 703 · 704 · 705 · 706 · 804 · 805 · 807 · 812 · 815-ho, 55, Digital-ro 34-gil, Guro-gu, Seoul, 08378, Rep. of Korea

**DOMESTIC SALES**      **T** 82.2.850.3500    **F** 82.2.850.3535    **E** jeil@jeilmed.co.kr

**INTERNATIONAL SALES**    **T** 82.2.850.3304    **F** 82.2.850.3537    **E** global@jeilmed.co.kr

[www.jeilmed.co.kr](http://www.jeilmed.co.kr)

Print Date: 2020-07-20    02-A03(00)